

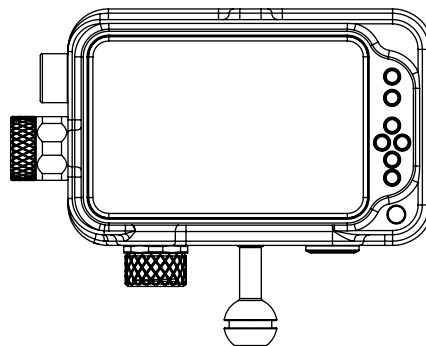

# MR5.5 监视器

2000nits 超高亮度



使用说明



 Website: [www.fotocore.com](http://www.fotocore.com)

 E-mail: [sales@fotocore.com](mailto:sales@fotocore.com)

 Room 201, Building 4, No. 31 Binhe Road, Zhangmutou  
TownDongguan City, Guangdong, China

### 产品简介：

欢迎使用本公司生产的5.5寸高亮摄影监视器。本监视器配备HDMI 输入和输出、辅助电源输出、HDR监看及支持用户3D LUT上载等特征。高级特性包括波形图、矢量图、直方图、音频柱、辅助对焦、伪色彩、斑马纹、点对点、中心标记、安全标记、遮幅标记、单色显示、图像静止、放大、变形模式等，是一款理想的便携式轻量级的取景配套监视器。



**使用产品前，为达到最佳使用效果，请阅读本说明书**

## 注意事项

1. 移动机器时慎防跌落导致机器严重损坏或损毁。
2. 此产品中的液晶屏由玻璃制成，如屏破损可能会造成其他伤害。
3. 保持产品远离热源，避免机器长时间暴露在阳光下，这将导致液晶屏的损坏。
4. 不要用化学试剂或溶剂擦洗机器，请用软布擦除机器上的尘污，以保证本机的亮丽。
5. 机内无用户可调组件，非专业人员请勿自行打开本机或自行尝试修理本产品，以免造成不必要的损坏。

## 产品特点

- 5.5 英寸 1920x1080 全高清 IPS 屏
- 支持HDR监看，直观按键操作
- 2000nits 高亮，阳光下可见
- 全新菜单界面，功能图标化，更加容易选取
- 3D LUT Log 灰片转换 Rec.709，支持用户 3D LUT 上传(多达 32 个)
- 全波形显示、波形图、矢量图、RGB 直方图、亮度直方图、辅助对焦、斑马纹、中心标记等功能，能帮助准确对焦和曝光，适用于前期拍摄、后期制作以及颜色校准

## 目 录

一、产品描述 .....	01
1.产品外观说明.....	02
2.供电方式 .....	03
二、按键操作说明 .....	04
三、菜单功能说明 .....	06
四、LUT导入说明 .....	11
五、产品技术参数 .....	12
六、常见故障排除 .....	13
七、售后服务 .....	14

# 一、产品描述

• 正面

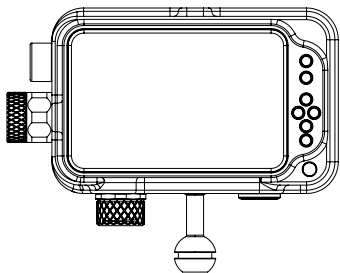

• 侧面

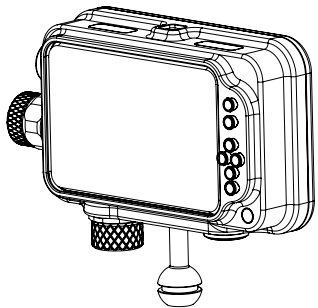

## 1、产品外观说明

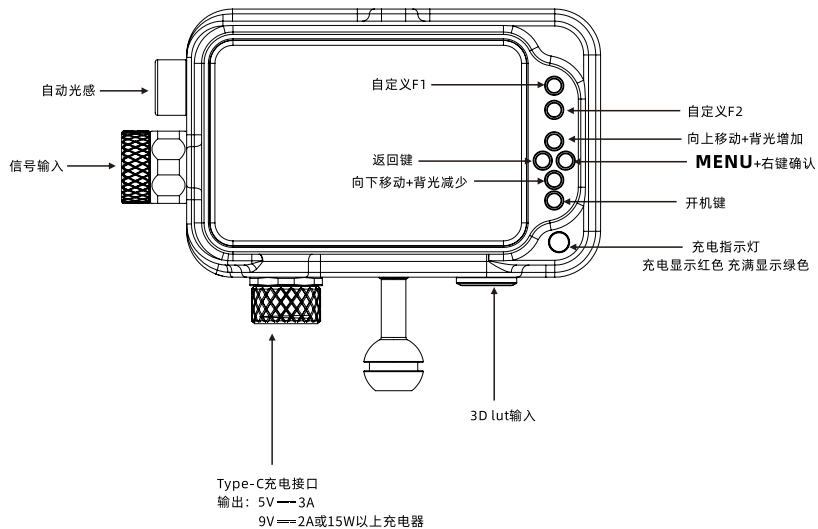

## 2、供电方式

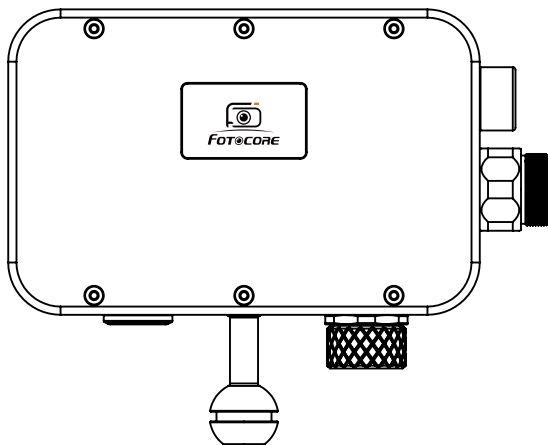

fotocore内置电池，Type-C 充电。

电池容量37wh(7.4Vx5.0Ah)，工作时间约4-8小时(根据环境光亮度变化)

工作电压5.4-8.4V。

## 二、按键操作说明

1. 监视器正确接入电源后指示灯亮（红色），长按  键3秒开机。
2. F1、F2为自定义键。

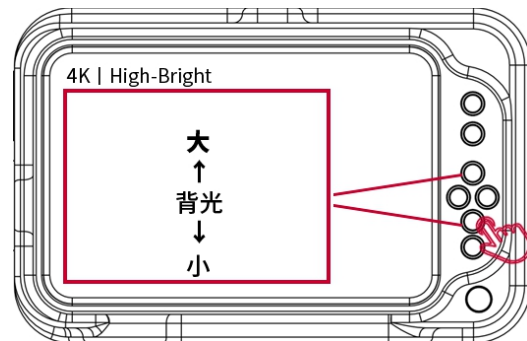

### 3. 按键菜单操作

- 按下“MENU”，可进入 OSD 主菜单，再按 MENU 键确认进入二级菜单，按动“左”或“右”可选择二级菜单。在选定二级菜单选项后，按 MENU 键确认进入功能菜单，按“V”或“^”键选择对应的功能或调整参数值，选定功能后按 开机键确认。
- 按左键返回或退出菜单。

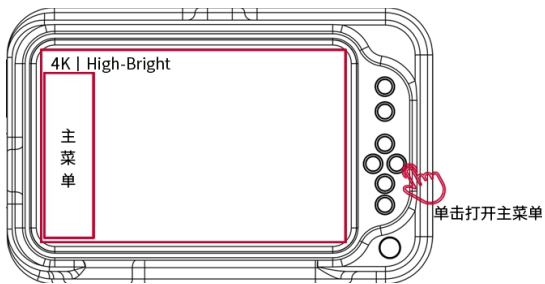

## 三、菜单功能说明



功能辅助

全波形	开、关 开启后，波形图、矢量图、直方图、音频柱全部显示，有助于更直观清晰的分析图像。
波形图	开、关 类型：RGB、YUV、灰度 波形图透明度：关、25%、50%、75% 位置 X:0-100 (移动波形图横向位置) 位置 Y:0-100 (移动波形图纵向位置)
矢量图	开、关 位置 X:0-100 (移动矢量图横向位置) 位置 Y:0-100 (移动矢量图纵向位置)
直方图	开、关 类型：RGB1、RGB2、灰度 位置 X:0-100 (移动直方图横向位置) 位置 Y:0-100 (移动直方图纵向位置)
辅助对焦	关、开 辅助对焦开启后可调整对焦水平(1~10) 对焦颜色(黄、红、绿、蓝、白)
音频柱	关、开
斑马纹	关、开 斑马纹开启后可调整斑马纹值(1%~100%)
单色显示	关、灰、红、绿、蓝
伪色彩	关、类型1、类型2
返回 ←	返回上一级菜单



## 线框辅助

网格	开、关
安全框	开、关80%、85%、90%、93%、96%、2.35:1 9:16、颜色：红、绿、蓝、黑、白、灰
中心标记	开、关、颜色：红、绿、蓝、黑、白、灰
比例标记	开、4:3、13:9、14:9、15:9、16:9、 1.85:1、2.35:1、9:16 颜色：红、绿、蓝、黑、白、灰 标记修饰
返回 ←	返回上一级菜单





## 图像显示

扫描模式	欠扫描、过扫描
显示比例	自动、16:9、16:10、4:3、5:4、1.85:1 2.35:1、全屏
变形模式	开、关、类型：1.33X、1.6X、2.0X MAG、用户
图像翻转	开、关 左右翻转、上下翻转、全局翻转
缩放模式	开、关、类型：2X、4X、9X、16X、用户
图像冻结	开、关
点对点	关、100%~500%
图像静止	开、关
返回 ←	返回上一级菜单





## 用户选项

Lut	开、关 Lut导入确认、Lut列表(system-Slog2 to S709.cube、system-Slog3 to S709.cube、system-SlogC to S709.cube、system-VLog to S709.cube)
HDR	开、关、类型HLG1、HLG2、HLG3
显示调整	背光、亮度、对比度、饱和度、色调, 自定义调整 
色彩调整	显示范围: 自动、Limit、Full 5600K、6500K、的红、绿9300K、自定义; 在“自定义”下, 可对图像、蓝数值进行调整
快捷键	全波形、波形图、矢量图、直方图、音频柱、中心标记、安全框、网格、辅助对焦、伪色彩、过曝、变形模式、图像冻结、单色显示、图像翻转显示比例、比例标记 设置监视器面板上的2个快捷键F1、F2的自定义功能 例: 双击屏幕打开主菜单, 单击用户选项的 <b>F</b> 快捷键, 点击F1选择上述功能之一如“全波形”, 选中后光标显示浅灰色。退出菜单后, 在监视器面板上按F1键, 就可以直接打开“全波形”功能。F2的设置以此类推
返回 	返回上一级菜单

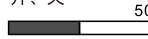

## 系统设置

用户切换	1、2、3、4
菜单语言	中文、繁體中文、日本語、Deutsch、Français、Italiano、Español、한국、Русский、English
OSD 菜单选项	菜单时间: 关、15秒、30秒、40秒 菜单透明度: 关、25%、50%、75 无信号: 红、绿、蓝、黑、白、灰
EDID设置	EDID设置: 2.0、1.4
音量	静音: 开、关 音量: 
复位	选中复位确认选项后恢复出厂设置
固件更新	将更新文件拷贝到SD卡后, 插进SD卡槽, 可点击固件更新选项中确认键更新。 注: 插SD卡时芯片要朝上, 插完要按一下以确保SD卡有完全插进去
返回 	返回上一级菜单

## 四、LUT 导入说明

1. U 盘格式支持 FAT32

2. 文件限制最多 32 个 Lut 文件

3. 文件要求

- LUT 文件格式后缀为 **.cube** (不区分大小写)
- 单个文件不得超过 **7.9M**。
- 支持 LUT\_3D\_SIZE 为 **16,17,32,33,64,65** 的文件  
满足以上要求为有效文件
- LUT 文件名要求用英文或数字，避免无法识别，导致提示不正确的文件名。

4. 导入步骤

- (1) 确保将 U 盘插入 TYPE-C 转 USB 头，再插入本机的 TYPE-C 接口
  - (2) 进入主菜单用户选项--LUT--LUT 导入--点击确认导入系统会先识别 U 盘
- 如果 U 盘中存在有效的文件，则会文件存入设备，并提示信息"**[n]name**"，其中 n 表示当前正存入第 n 个(n 不大于 32)，name 为当前导入的 LUT 文件名称。
  - 如何清空已导入的 LUT  
插入一个空的 U 盘（即里面没文件），进入主菜单  -- LUT--Lut导入--点击确认即可清空已导入的 LUT

## 五、产品技术参数

屏幕尺寸	5.5英寸
分辨率	1920 x 1080 pixels
点距	0.069(L) x 0.069(W)(mm)
显示比例	16:9
亮度	2000cd/m <sup>2</sup>
对比度	1000:1
可视角度	80°/80°(L/R)80°/80°(U/D)
背光源	LED
输入	HDMI
输出	HDMI
电源输入	内置电池包：电池容量37wh(7.4Vx5.0Ah),工作时间约4-8小时(根据环境光亮度变化),工作电压5.4-8.4V
输入电压	7~24V
消耗功率	≤9W
外观尺寸	171L x 111H x 46.5D(mm)
重量	1140g (含电池陆地重量)
安装方式	2个M6标准快装螺丝孔（底部、顶部）
工作温度	-20°C~70°C
存储温度	-30°C~80°C
提示：请务必使用30W以上的充电器	

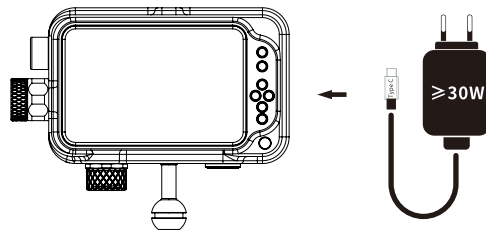

## 六、常见故障排除

1、黑白图像或单色图像:

- ① 确认彩色级别的饱和度和亮度、对比度的调整是否合适
- ② 监视器的“单色”是否处于黑白或其他单色图像状态。

2、接上电源开启后无图

- ① 查看信号连接线接触是否良好。
- ② 请确保使用标准的适配器连接到监视器；如果是由电池供电，请检查电池是否处于充满电状态。

■ 备注：若仍存在其它问题,请联系我们的相关技术人员。

★ 由于我们在不断努力提高产品功能和产品性能，说明书如有变更，恕不另行通知。

## 七、售后服务

所有FOTOCORE产品具有保修期，有缺陷的产品可以在自购买15天内通过当地分销商/经销商处免费更换。15天后所有缺陷/故障FOTOCORE产品将进入免费期限，免费维修期为购买之日起15个月内。超过15个月将进入有限保修期，将收取劳动力成本，但不收取配件或更换零件费用。

不在保修范围之内的情況如下：

- 1.本产品被私自拆卸，未经授权重建和/或维修。
- 2.本产品通过使用不当损坏。
- 3.产品电池泄漏损坏，含未及时保养造成的损坏。

有关FOTOCORE产品和服务的最新消息，请联系贵国经销商或发送电子邮件至sales@fotocore.com

FOTOCORE全系产品数据以官方网站数据为准。

T E L : +86-769-87199220  
F A X : +86-769-87199220  
E-mail : sales@fotocore.com  
W e b : www.fotocore.com



Made in China



# MR5.5 Monitor

2000 ultra-high brightness

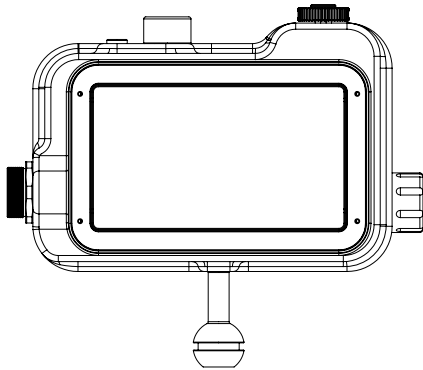

## User Manual

### **Brief Introduction:**

Welcome to choose and use the 5.5" high-brightness camera monitor produced by our company. This monitor is equipped with HDMI input and output, auxiliary power output, HDR monitoring and support for user 3D LUT on loading characteristics. Advanced monitor features include Waveform Graphs, Vector Graphs, Histograms, Audio Columns, Focus Assist, False Colors, Zebra Exposure, Dot by Dot, Center Marks, Safety Marks, Banner Marks, Monochrome Display, Image Still, Magnification, Anamorphic Mode, etc. MR5.5 Monitor is an ideal portable lightweight viewfinder matching monitor.



**In order to achieve the best effect,  
please read this user manual before starting to use it.**

## Precautions

1. Be careful not to drop it and cause serious damage or damage to the machine when moving the machine.
2. The LCD screen is made of glass. Hence it may cause other injuries if the screen is broken.
3. Keep it away from heat sources and avoid the machine being exposed to sunlight for a long time, which will cause damage to the LCD screen.
4. Do not scrub the machine with chemical reagents or solvents. Please use a soft cloth to wipe off the dust on the machine to ensure the brightness of the machine.
5. There are no user-adjustable components inside the machine. Non-professionals are not allowed to open the machine or try to repair it to avoid unnecessary damage.

## Monitor Software Features

- 5.5-inch 1920x1080 Full HD IPS display/screen.
- Ultra-bright 2000nit, clearly visible under the sun
- Support HDR monitoring,Intuitive button controls
- A redesigned menu with intuitive icons for easier navigation.”
- 3D LUT Log to Rec.709 conversion, with support for user-uploaded 3D LUTs (up to 32).
- Features like waveform, vectorscope, histograms, focus assist, zebra stripes, and center markers ensure accurate focus and exposure. Perfect for shooting, editing, and color grading

## Table of contents

I. Product description.....	19
I-1. Product appearance description .....	20
I-2. Power supply mode .....	21
II. Button Operation Instructions .....	22
III. Menu function description .....	24
IV. LUT Import Instructions.....	29
V. Product Technical Parameters.....	30
VI. Common Malfunction Resolution.....	31
VII. After-sales Service .....	32

# I. Product description

- Front

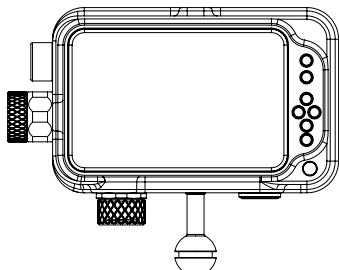

- Side

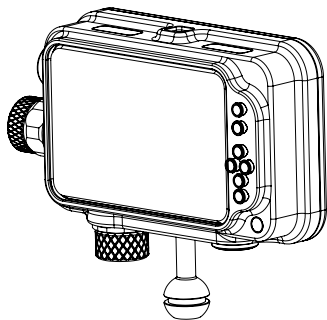

## I-1. Product appearance description

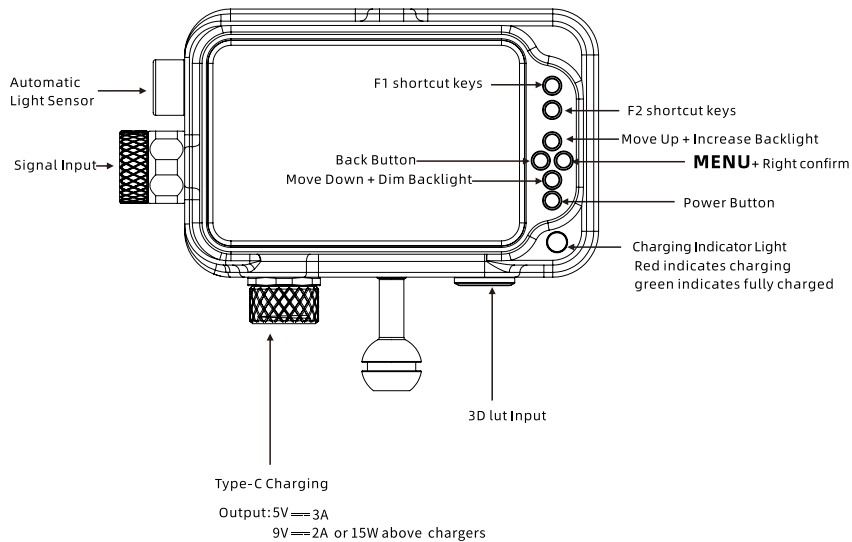

## I-2. Power supply mode

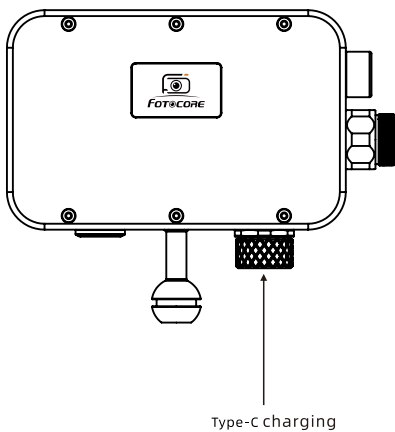

Fotocore with built-in battery, Type-C charging

Battery Capacity: 37Wh (7.4Vx5.0Ah)

Depends on environment light, working time: 4-8 hours.

Working Voltage: 5.4-8.4V

## II. Button Operation Instructions

- The indicator light is on (red) after this monitor is correctly to the power supply. Hold the  switch for 3 second to open and close
- F1 and F2 are customizable shortcut keys.

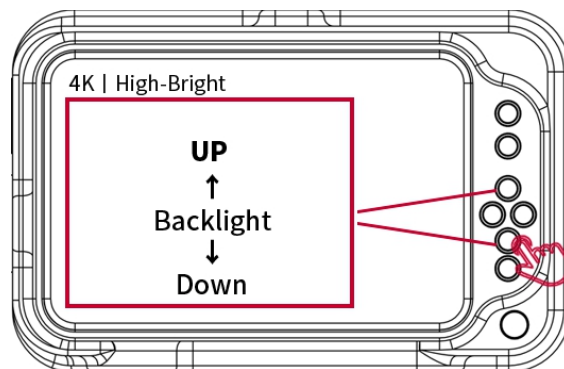

### 1. Button Menu Operation

- Press "MENU" to enter the OSD main menu, then press the MENU button again to confirm and enter the submenu. Use the "Left" or "Right" buttons to navigate through the submenu options.
- After selecting a submenu option, press the MENU button to confirm and enter the function menu. Use the "V" or "A" buttons to choose the corresponding function or adjust parameter values. Once the desired function is selected, press the MENU button to confirm.
- Press the left button to return or exit the menu.

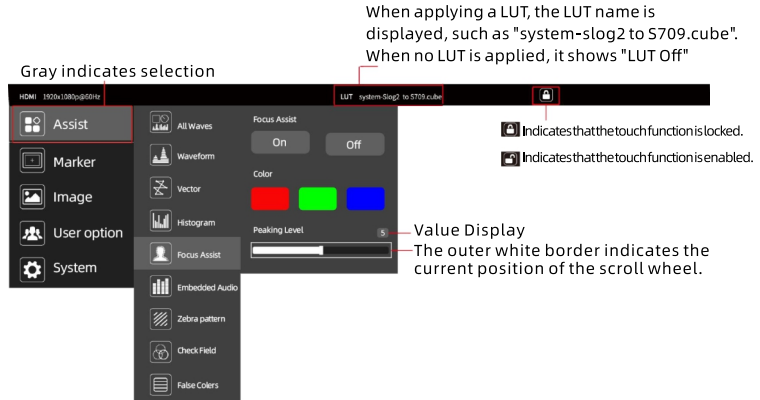
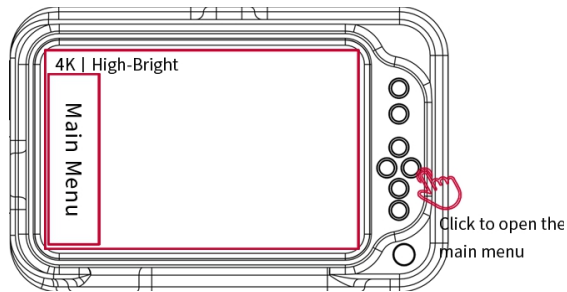

### III、Menu Function Description



All Waves	ON, OFF After turning on, waveform, vector, histogram and embedded audio will be shown.
Parade	OFF, RGB, YUV, Y This essential feature assists with the calibration of professional video cameras. It shows the overall brightness of the image assisting the video professional in correcting exposure. The waveform feature also checks the evenness of the lighting when lighting a chromakey or background.
Vector	ON, OFF Shows how saturated the image is and where the pixels in the image land on the color spectrum.
Histogram	ON, OFF
Focus Assist	ON, OFF After the Focus Assist is turned on, the Focus Level (1 ~ 10) and Focus Color (yellow, red, green, blue, white) can be adjusted.
Audio Meter	ON, OFF
Zebra	ON, OFF After the Zebra is turned on, the Zebra Value (1% ~ 100%) can be adjusted.
Monochrome	OFF, gray, red, green, blue
False Color	OFF, type 1, type2
Return ←	Back to the previous OSD menu



## Wireframe Assistance

Nine Grid	ON, OFF
Safety Marker	OFF, 80%、85%、90%、93%、96%、2.35:1、9:16、Color (yellow, red, green, blue, white)
Center Marker	ON, OFF, Color (yellow, red, green, blue, white)
Marker Mat	ON, 4:3、13:9、14:9、15:9、16:9、1.85:1、2.35:1、9:16; Color (yellow, red, green, blue, white).
Return ←	Back to the previous OSD menu





## Image Display

Scan Mode	Under Scan, Over Scan
Video Aspect	Auto, 16:9、16:10、4:3、5:4、1.85:1、2.35:1、Full Screen
Anamorphic Mode	ON, OFF, 1.33X、1.6X、2.0X MAG、User
Image Flip	ON, OFF Flip Horizontal、Flip Vertical、Flip Global
Scaling Mode	ON, OFF, Type: 2X、4X、9X、16X、User
Image Freeze	ON, OFF
Pixel to Pixel	OFF, 100% ~ 500%
Freeze	ON, OFF
Return ←	Back to the previous OSD menu





## User Options

Lut	ON, OFF After the LUT Switch is turned on, you can use the Lut (SLOG2, SLOG3, LOGC, VLOG).
HDR	OFF、HLG 2020、HLG 709、HLG P3
Display adjustment	Adjust backlight, brightness, contrast, saturation, and hue to your preference. 
Colortemp	5600K, 6500K, 9300K, user Under the "user", the red, green, and blue values of the image can be adjusted.
Keyboard shortcuts	Features include full waveform, vectorscope, histogram, audio levels, focus assist, false color, and more. Customize F1/F2 shortcuts for quick access to these tools.
Return 	Back to the previous OSD menu



## System Settings

User switching	1、2、3、4
Language	中文, 繁體中文, 日本語, Deutsch, Français, taliano, Español, 한국, Русский, English
OSD Time	Menu timeout: Off/15s/30s/40s Menu opacity: Off/25%/50%/75% No signal color: Red/Green/Blue/Black/White/Gray
EDID settings	EDID settings: ■ 2.0、1.4
Volume	Mute: On, Off Volume: 
Reset	Confirm reset to restore factory settings.
Firmware Update	Copy the update file to the SD card, insert it into the slot (chip facing up), and click 'Confirm' in the firmware update menu. Press the card gently to ensure it's fully inserted.
Return 	Back to the previous OSD menu

## IV. LUT Import Instructions

1. USB drive format supports FAT32
2. The file limit is a maximum of 32 LUT files
3. File Requirements
  - LUT file format suffix is **.cube** (case insensitive)
  - Single file size must not exceed 7.9M.
  - Supports files with LUT\_3D\_SIZE of **16, 17, 32, 33, 64, 65**
 Files meeting the above requirements are considered valid
  - LUT file names should be in English or numbers to avoid unrecognized names, which may result in incorrect file name prompts.

### 4. Import Steps

- (1) Ensure that the USB drive is inserted into the TYPE-C to USB adapter, and then connect it to the TYPE-C port of the device.
- (2) Navigate to the main menu user options -- LUT -- LUT Import -- click to confirm import. The system will first recognize the USB drive.
  - If valid files exist in the USB drive, they will be saved to the device, and a prompt message "[n]name" will be displayed, where n indicates the nth file currently being saved (n not exceeding 32), and name is the name of the currently imported LUT file.
  - How to Clear Imported LUT
 Insert an empty USB drive (i.e., with no files inside), navigate to the main menu  --LUT -- LUT Import -- click to confirm, and the imported LUTs will be cleared."

## V. Technical Parameters

Panel Size	5.5" touch screen
Resolution	1920 x 1080 pixels
Dot Pitch	0.069(L) x 0.069(W)(mm)
Aspect Ratio	16:9
Brightness	2000cd/m <sup>2</sup>
Contrast	1000 : 1
Viewing Angle	80°/80°(L/R) 80°/80°(U/D)
Backlight	LED
Input	HDMI
Output	HDMI
Power Input	Built-in battery pack: Battery capacity 37Wh (7.4V x 5.0Ah), Depends on environment light, working time: 4-8 hours, operating voltage 5.4-8.4V.
Input Voltage	7~24V
Power Consumption	≤9W
Unit Size	171Lx111Hx46.5D (mm)
Unit Weight	1140g (on land with battery)
Mount Points	2 M6 standard quick-release screw holes (bottom, top).
Working Temperature	-20°C ~ 70°C
Storage Temperature	-30°C ~ 80°C
Note: Using an 30W or higher charger is mandatory	

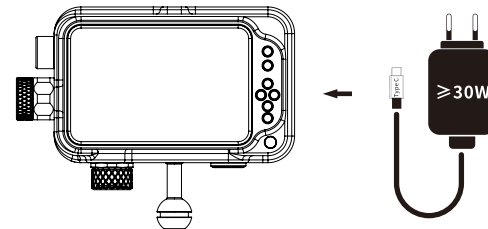

## VI. Common Malfunction Resolution

1. Black&white image or monochrome image:

- ① Check whether the saturation, brightness and contrast of the color level are properly adjusted.
- ② Whether the "monochrome" of the monitor is in black and white or other monochrome image status.

2. There is no picture after the power is turned on

- ① Check whether the signal connection line is in good contact.
- ② Please make sure to use a standard adapter to connect to the monitor; If powered by battery, please check that the battery is fully charged.

■ Remarks: If you still have other problems, please contact our relevant technical personnel.

★ Due to our continuous efforts to improve product functions and product performance, the instructions are subject to change without notice.

## VII. After-sales Service

All products are warranted for quality. Defective products can be exchanged for replacement through a local distributor/dealer within 15 days of purchase. After 15 days, all defective/malfunctioning products will be repaired free of charge for period of 15 months from the date of purchase. Beyond 15 months, a limit warranty applies, covering the cost of labor, but not the cost of accessories or replacement parts. The warranty is nullified in all of the following situations:

- 1. The product(s) is/are disassembled, reconstructed and/or modified by unauthorized parties.
- 2. The product(s) is/are damaged through improper use.
- 3. The product(s) is/are damaged by leakage of batteries.

For the latest information on products and services, please contact your national distributor or send an email to [sales@fotocore.com](mailto:sales@fotocore.com).

The official website shall prevail in case of any product data changes.

T E L : +86-769-87199220  
F A X : +86-769-87199220  
E-mail : [sales@fotocore.com](mailto:sales@fotocore.com)  
W e b : [www.fotocore.com](http://www.fotocore.com)



Made in China